



HOT DEALS

2024



EINFACH VIGOR.

Valid from 01/03/2024 to 31/08/2024 – errors excepted



HOT24-1/EN/XX/0

VIGOR
SERIES **XXL**

EXTRA DEEP!

In a class of its own!

V4481-XXL/929

EAN 4047728082303



L x W x H
1625 x 695 x 1017 mm

EXTRA WIDE!



Discover a new dimension of reality!

929

tools including tool trolley



Top		Left		Right	
60 kg 3 x	30 kg 10 x	1425 x 563 x 100 mm 1 x	563 x 563 x 75 mm 5 x	563 x 563 x 154 mm 1 x	790 x 563 x 75 mm 5 x
1000 kg		RAL 9005		RAL 7012	



Including can holder V2398-XD



8000 cm² stainless steel work surface

Over 80 litres capacity in one drawer
1425 x 563 x 100 mm

Socket strip including 2 x USB and 2 x USB-C as well as 2 metre H07 cable with safety plug

Heavy-duty castors for up to 1000 kg load capacity

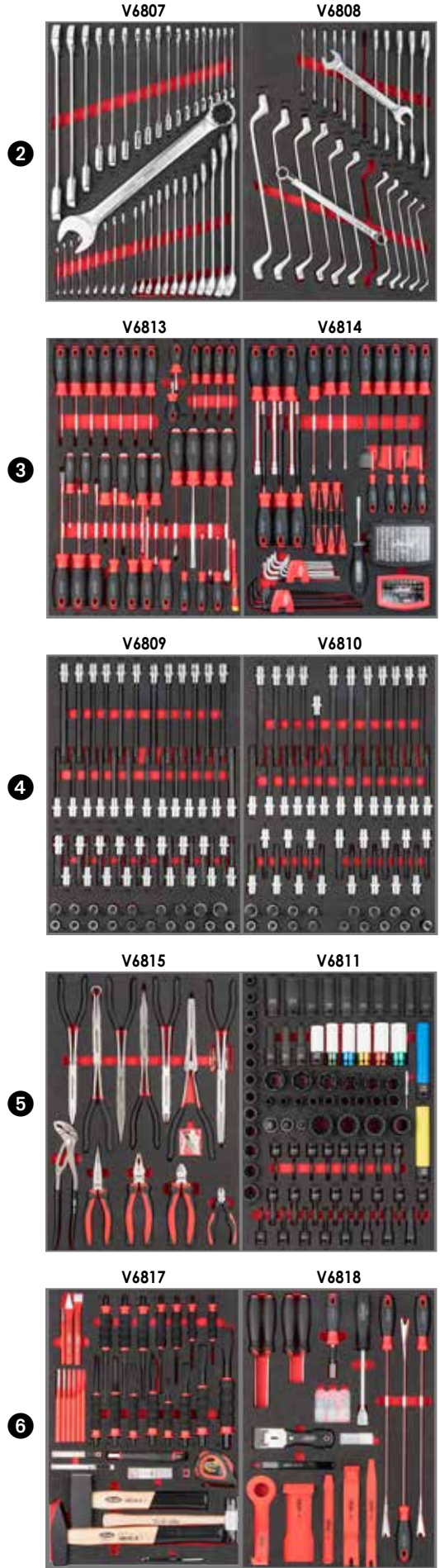

New

Our Series M, L, XL and XD trolleys are now supplied with rubberised smooth-running castors!



77% less noise!

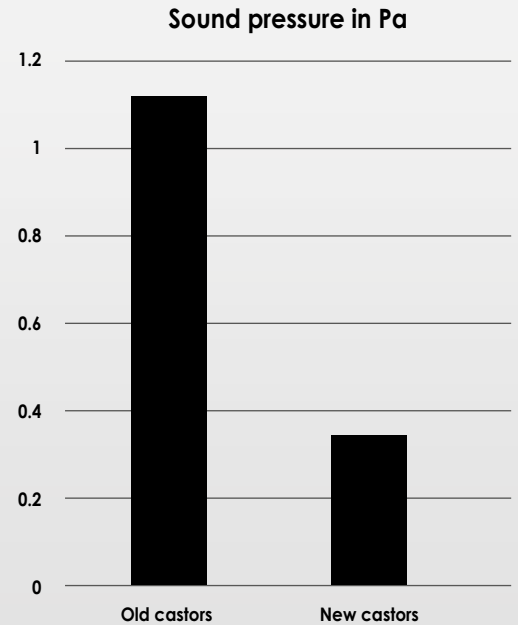

- Reduction of the noise level by 77 % compared to previous castors
- Significantly reduced move-off and steering forces
- Substantial increase in rolling comfort
- Unevenness / joints in the floor are perfectly cushioned
- No "rattling" of the trolley on uneven surfaces



L x W x H
986 x 695 x 1017 mm

VIGOR SERIES XD

EXTRA DEEP!

The space saver!



8 x	7 x 790 x 570 x 75 mm	1 x 790 x 570 x 154 mm	500 Kg			RAL 9005 / 7012	
-----	--------------------------	---------------------------	--------	--	--	-----------------	--

Select your assortment for the trolley!

V4481-XD/469

EAN 4047728068512

ASSORTMENT 1

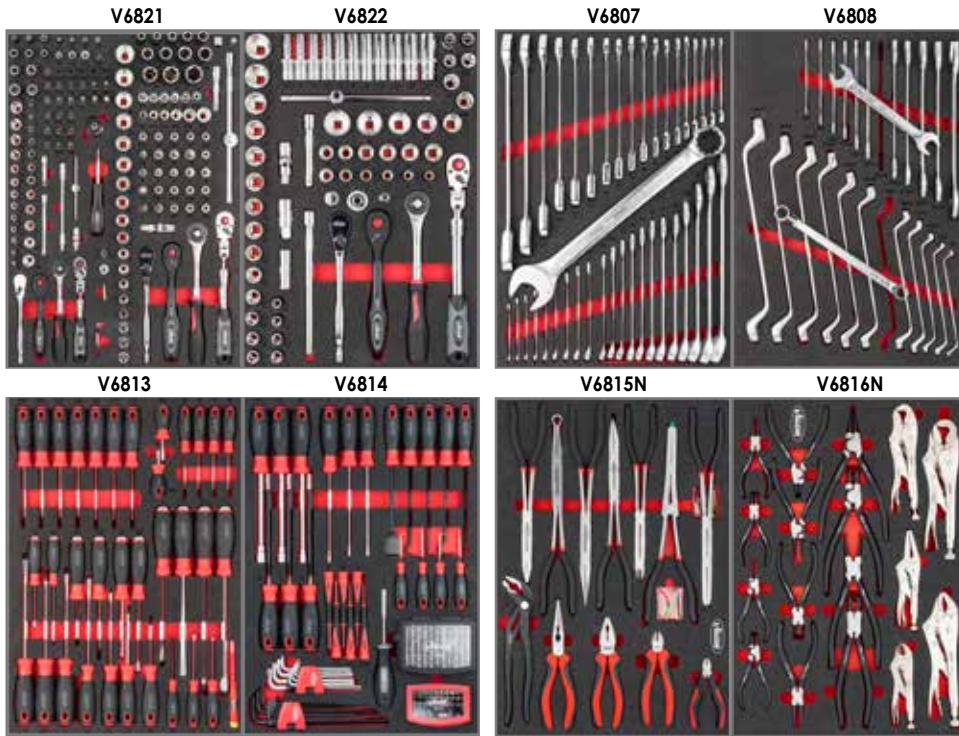

469

tools including
tool trolley

+469

V4481-XD/775

EAN 4047728068529

ASSORTMENT 2

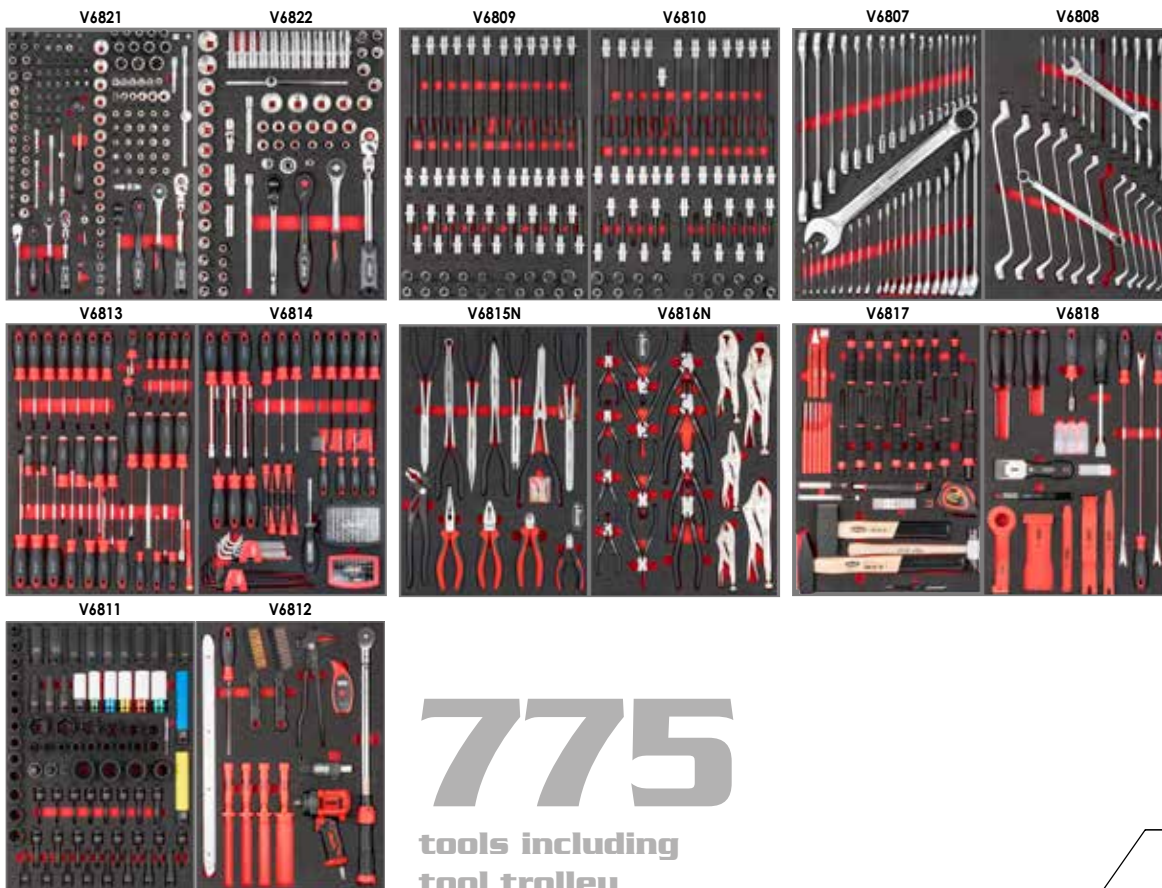

775

tools including
tool trolley

+775





With stainless steel worktop

L x W x H
1017 x 940 x 514 mm



VIGOR
SERIES XL

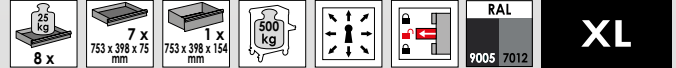

Select your assortment for the trolley!

V4481-X/499

EAN 4047728062367

ASSORTMENT 1

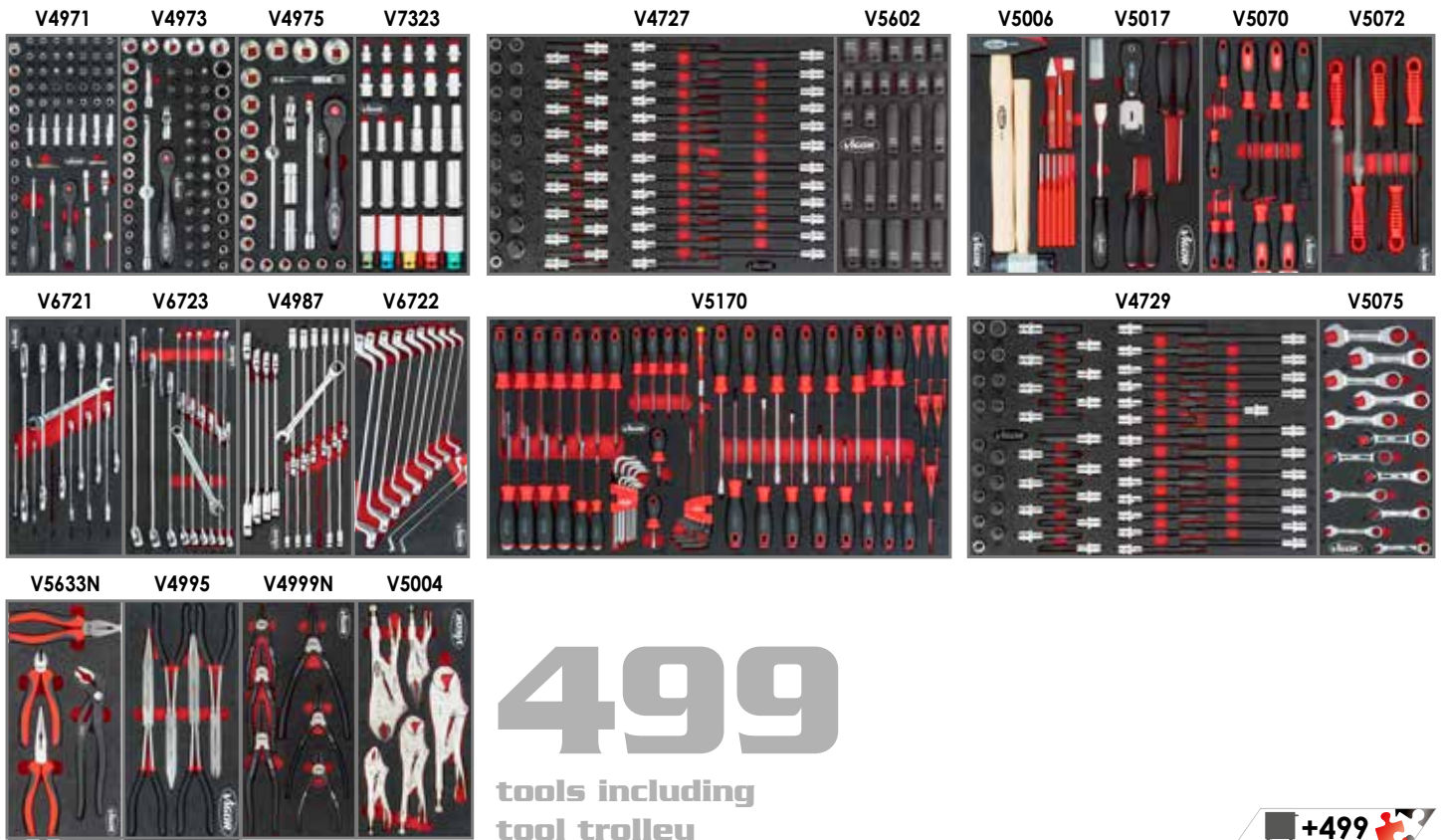

499
tools including
tool trolley

+499



VIGOR No.	Designation	kg	EAN
V5434	Tool trolley with plastic worktop and assortment 1	141	054348

V4481-X/466

EAN 4047728074674

ASSORTMENT 2

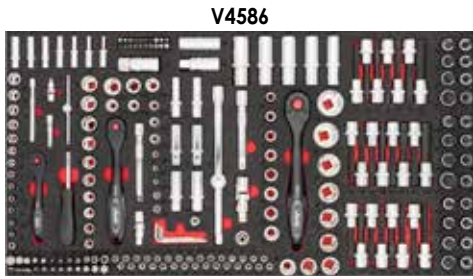

V4586



V6650



V7015N



V6015



V5170



466

tools including
tool trolley

+466

V4481-X/375

EAN 4047728062350

ASSORTMENT 3



V4586



V6650



V5170



V5638N

375

tools including
tool trolley

+375

VIGOR No.	Designation	kg	EAN 4047728+
V4542	Tool trolley with plastic worktop and assortment 3	117	045421





With stainless steel worktop



VIGOR
SERIES L

New

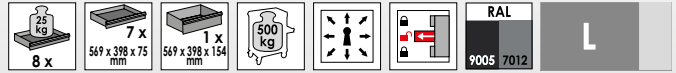

L x W x H
756 x 481 x 1002 mm

Select your assortment for the trolley!

V1901-X/442

EAN 4047728084338

ASSORTMENT 1

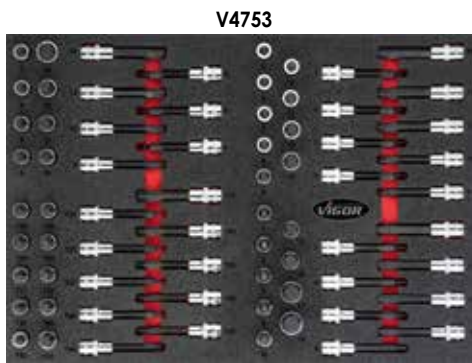

New

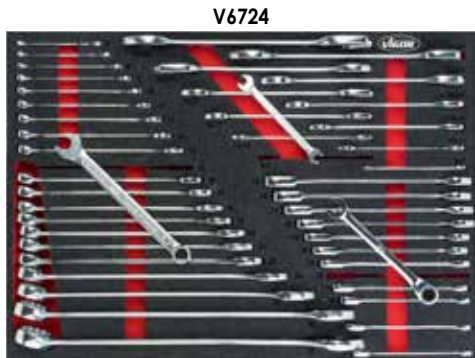

442
tools including
tool trolley

+442

V1901-X/376

EAN 4047728**084192**

ASSORTMENT 2

V4188



V4753

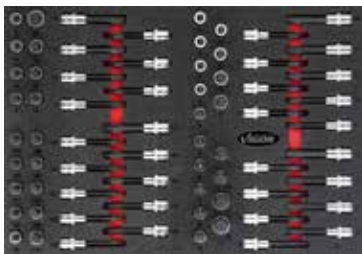

V6724



376

tools including
tool trolley

V5068



V5070



V5006



V5633N



V5603



V7324



+376

VIGOR No.	Designation	kg	EAN 4047728+
V1901/376	Tool trolley with plastic worktop and assortment 2	100	080293



V4560-X

EAN 4047728**084178**

ASSORTMENT 3

V4188



V6643



344

tools including
tool trolley

V4230



V5637N



V2837

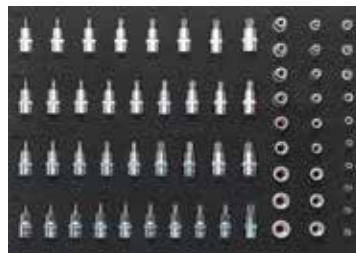

+344



VIGOR No.	Designation	kg	EAN 4047728+
V4560	Tool trolley with plastic worktop and assortment 3	95	045605

V2712N

EAN 4047728**055451**

VIGOR
SERIES **M**

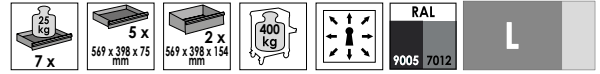

With mat

L x W x H
681 x 460 x 1016 mm



V5115N



V2837



V5111N



V6726

320

tools including
tool trolley

+320

V2379N

EAN 4047728**055444**

VIGOR
SERIES **M**



With mat

L x W x H
681 x 460 x 1016 mm



V5116



V6726



V5111N

256

tools including
tool trolley

+256

V4481-XXL

EAN 4047728080491

VIGOR SERIES XXL

Extra-deep tool trolley without assortment · with stainless steel worktop



LD XD XXL

3 x	10 x	Top 1425 x 543 x 100 mm	Left 563 x 563 x 75 mm	Right 563 x 563 x 154 mm	790 x 563 x 75 mm	790 x 543 x 154 mm

V4481-XD

EAN 4047728066488

VIGOR SERIES XD

Extra-deep tool trolley without assortment · with stainless steel worktop



8 x	790 x 570 x 75 mm	790 x 570 x 154 mm						XD
-----	-------------------	--------------------	--	--	--	--	--	-----------

V4481-X

EAN 4047728060721

VIGOR SERIES XL

Tool trolley without assortment · with stainless steel worktop

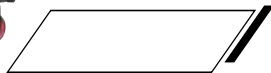

8 x	753 x 398 x 75 mm	753 x 398 x 154 mm						XL
-----	-------------------	--------------------	--	--	--	--	--	-----------

V4481

EAN 4047728044813

Tool trolley without assortment · with plastic worktop

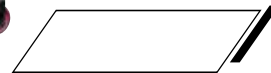

V1901-X

EAN 4047728083072

VIGOR SERIES L

Tool trolley without assortment · with stainless steel worktop



New



7 x	569 x 398 x 75 mm	569 x 398 x 154 mm						L
-----	-------------------	--------------------	--	--	--	--	--	----------

V1901

EAN 4047728019019

Tool trolley without assortment · with plastic worktop

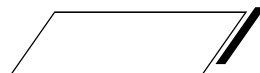

V6000-058

EAN 4047728083416

Corner wall cabinet

- Can be retrofitted into existing systems
- For 500 mm deep corner configurations
- Optimal storage of tools or consumables

New

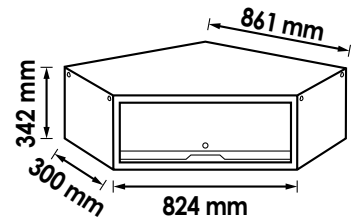

V6000-057XL

EAN 4047728083065

Washbasin lower cabinet

- Can be retrofitted into existing systems
- Full-length sink made of 18/10 stainless steel
- Preparation for the installation of a tap (not included in delivery)
- Including continuous back panel made of 18/10 stainless steel (mounting on VIGOR perforated tool panel bracket)
- Including drain and corresponding hose

New

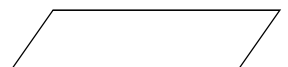
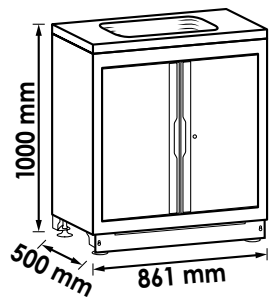

V6000-056XL

EAN 4047728084215

Integrated refrigerator

New

Put the finishing touches to your storage system!

The V6000-056XL refrigerator, which can be integrated into the storage system, is not only a practical eye-catcher, but also a statement of style and elegance.

Key features and benefits:

1. **Modern design:** The V6000-056XL impresses with its elegant design in high-gloss black, which adds a luxurious touch to any workshop. Its sleek, contemporary look harmonises perfectly with the Vigor storage system while adding a stylish accent.
2. **Generous capacity:** Thanks to its intelligent interior design and the height-adjustable insert grids, the V6000-056XL offers enough space for up to 220 330 ml beverage cans (186 litres total volume)
3. **Intelligent functions:** The V6000-056XL is equipped with a digital display that allows you to set the temperature precisely and effortlessly, in the range 0 – 10° C. This refrigerator also has LED lighting that can be switched off, which not only ensures even illumination of the interior, but also elegantly emphasises the contents.
4. **Durability:** Manufactured from high-quality materials and with a first-class finish, the V6000-056XL impresses with its durability and reliability.
5. **Simple installation:** Thanks to the base frame supplied, the refrigerator can be easily installed in the storage system.

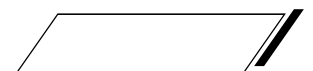
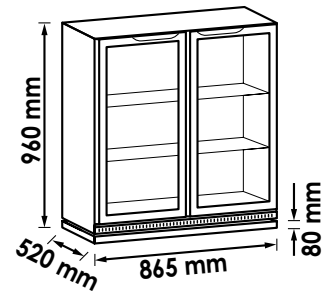

Always good - even without revolution!



V2414N

EAN 4047728**056434**

1/4" socket set

• For manual operation

- 1/4 4 · 4.5 · 5 · 5.5 · 6 · 7 · 8 · 9 · 10 · 11 · 12 · 13 · 14 mm
- 1/4 3 · 4 · 5 · 6 · 7 · 8 mm
- 1/4 0.8x4 · 1x5 · 1.2x6.5 · 1.2x7 mm
- 1/4 PH 1 · PH 2 · PH 3
- 1/4 PZ 1 · PZ 2 · PZ 3
- 1/4 T 10 · T 15 · T 20 · T 25 · T 30 · T 40
- 1/4 150 mm



46

V3734N

EAN 4047728**056427**

1/4" socket set

• For manual operation

- 1/4 4 · 4.5 · 5 · 5.5 · 6 · 7 · 8 · 9 · 10 · 11 · 12 · 13 mm
- 1/4 PH 1 · PH 2
- 1/4 PZ 1 · PZ 2
- 1/4 T 15 · T 20 · T 25 · T 30
- 1/4 150 mm



23

V2305N

EAN 4047728**056441**

3/8" socket set

• For manual operation

- 3/8 6 · 7 · 8 · 9 · 11 · 12 · 13 · 14 · 15 · 16 · 17 · 18 · 19 · 20 · 21 · 22 · 24 mm
- 3/8 8 · 9 · 10 · 11 · 12 · 13 · 14 · 15 · 17 · 19 mm
- 3/8 3 · 4 · 5 · 6 · 7 · 8 · 10 mm
- 3/8 0.8x5.5 · 1x7 · 1.2x8 mm
- 3/8 PH 1 · PH 2 · PH 3
- 3/8 PZ 1 · PZ 2 · PZ 3
- 3/8 T 15 · T 20 · T 25 · T 27 · T 30 · T 40 · T 45 · T 50 · T 55
- 3/8 200 mm



61



V2460NEAN 4047728**056458****1/2" socket set**

• For manual operation

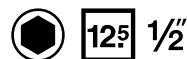

- 10 · 11 · 12 · 13 · 14 · 15 · 16 · 17 · 18 · 19 · 20 · 21 · 22 · 23 · 24 · 27 · 30 · 32 mm
- 250 mm



25

V1706NEAN 4047728**056465****Socket set**

• For manual operation



- 4 · 4.5 · 5 · 5.5 · 6 · 7 · 8 · 9 · 10 · 11 · 12 · 13 · 14 mm
- 6 · 7 · 8 · 9 · 10 · 11 · 12 · 13 mm
- 3 · 4 · 5 · 6 mm
- 0.8x4 · 1x5.5 · 1.2x7 mm
- PH 1 · PH 2
- PZ 1 · PZ 2
- T 8 · T 10 · T 15 · T 20 · T 25 · T 30
- T 8 H · T 9 H · T 10 H · T 15 H · T 20 H · T 25 H · T 27 H · T 30 H
- 150 mm
- 10 · 11 · 12 · 13 · 14 · 15 · 16 · 17 · 18 · 19 · 20 · 21 · 22 · 23 · 24 · 27 · 30 · 32 mm
- 14 · 15 · 17 · 19 · 22 mm
- 250 mm



94

V2461NEAN 4047728**056472****Socket set**

• For manual operation



- 4 · 4.5 · 5 · 5.5 · 6 · 7 · 8 · 9 · 10 · 11 · 12 · 13 · 14 mm
- 4 · 5 · 6 · 7 · 8 · 9 · 10 mm
- E 4 · E 5 · E 6 · E 7 · E 8
- 3 · 4 · 5 · 6 mm
- 0.8x4 · 1x5 · 1.2x6.5 · 1.2x7 mm
- PH 0 · PH 1 · PH 2
- PZ 0 · PZ 1 · PZ 2
- T 8 · T 9 · T 10 · T 15 · T 20 · T 25 · T 27 · T 30
- T 8 H · T 9 H · T 10 H · T 15 H · T 20 H · T 25 H · T 27 H · T 30 H
- 150 mm
- 10 · 11 · 12 · 13 · 14 · 15 · 16 · 17 · 18 · 19 mm
- 10 · 11 · 12 · 13 · 14 · 15 mm
- E 10 · E 11 · E 12 · E 14 · E 16 · E 18
- 200 mm
- 10 · 11 · 12 · 13 · 14 · 15 · 16 · 17 · 18 · 19 · 20 · 21 · 22 · 24 · 27 · 30 · 32 mm
- 16 · 17 · 18 · 19 · 22 mm
- E 20 · E 24
- 250 mm



172

V3277N

EAN 4047728**056489**

Socket set

• For manual operation

- 4 · 4.5 · 5 · 5.5 · 6 · 7 · 8 · 9 · 10
 11 · 12 · 13 · 14 mm
- 4 · 5 · 6 · 7 · 8 · 9 · 10 mm
- E 4 · E 5 · E 6 · E 7 · E 8
 150 mm

- 10 · 11 · 12 · 13 · 14 · 15 ·
 16 · 17 · 18 · 19 mm
- 10 · 11 · 12 · 13 · 14 · 15 mm
- E 10 · E 11 · E 12 · E 14 · E 16 · E 18
 198 mm

- 13 · 14 · 15 · 16 · 17 · 18 · 19 ·
 20 · 21 · 22 · 24 · 27 · 30 · 32 mm
- 16 · 17 · 18 · 19 · 22 mm
- E 20 · E 22 · E 24
 250 mm

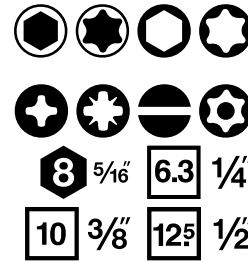

212

V4425N

EAN 4047728**058919**

Socket set

• For manual operation

- 4 · 4.5 · 5 · 5.5 · 6 · 7 · 8 ·
 9 · 10 · 11 · 12 · 13 · mm
- 3 · 4 · 5 · 6 mm
- 0.8x4 · 1x5.5 · 1.2x6.5 mm
- PH 1 · PH 2 · PH 3
- PZ 1 · PZ 2 · PZ 3
- T 10 · T 15 · T 20 · T 25 · T 30 · T 40
 150 mm

- 10 · 11 · 12 · 13 · 14 · 15 · 16 · 17 · 19 ·
 20 · 21 · 22 · 24 · 27 · 30 · 32 mm
- 250 mm

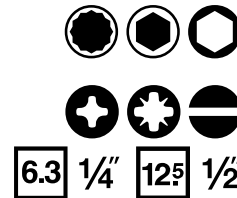

95

V2318N

EAN 4047728**059299**

3/4" socket set

• For manual operation

- 19 · 21 · 22 · 23 · 24 · 26 · 27 · 28 · 30
 32 · 34 · 36 · 38 · 41 · 46 · 50 mm
- 500 mm

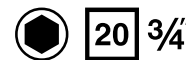

21



V5461

EAN 4047728080323

Socket set

• For manual operation

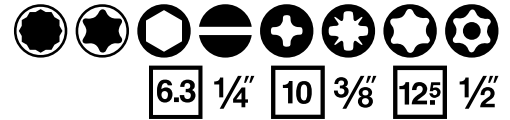

12-point design

» **For components see catalogue page 175**



133

V7031

EAN 4047728082624

Ratcheting box-end wrench set · extra long

- At least 60 % longer than standard ratchet wrenches – for greater power transmission
- Slim design
- Tool roll
- Surface chrome-plated, polished
- Number of teeth: 72 (operating angle 5°)



New



VIGOR No.	Size	Length mm	EAN 4047728+
V7031-10	10	257	082938
V7031-11	11	270	082945
V7031-12	12	283	082952
V7031-13	13	295	082969
V7031-14	14	337	082976
V7031-15	15	349	082983
V7031-16	16	362	082990
V7031-17	17	375	083003
V7031-18	18	388	083010
V7031-19	19	401	083027

10

V7920N

EAN 4047728081702

T-plus socket set

- T-Plus profiles are installed in BMW · VAG · MERCEDES-BENZ · AUDI · MAN · FORD · OPEL · MAZDA · TOYOTA · TESLA · NISSAN · RENAULT · SUBARU · GM · CHEVROLET
- IP: wheel bearing · engine · gearbox · cam adjuster · flywheel · timing belt housing · seat belt anchorages
- IPR: engine · control unit · generators · side mirrors · plug-in pumps · air flow meters
- EP: gearbox · clutch and flywheel · crankshaft bolt · exhaust nuts · engine mount
- EPR: interior trim · door handles · rear lights · headlights · electrical connections · bumper beams · suspension parts · brakes

6.3 1/4" 10 3/8" 12.5 1/2"



T-profile



T-plus profile

Now with even more special profiles!



Size	Profile	Socket Part Numbers
6.3 1/4"		IP8 · IP10 · IP15 · IP20 · IP25 · IP27 · IP30
		IP40 · IP45 · IP50 · IP55 · IP60
12.5 1/2"		IPR8 · IPR10 · IPR15 · IPR20 · IPR25 · IPR27 · IPR30
		IPR40 · IPR45 · IPR50 · IPR55 · IPR60
6.3 1/4"		EP4 · EP5 · EP6 · EP7 · EP8
10 3/8"		EP10 · EP11 · EP12 · EP14 · EP16
12.5 1/2"		EP18 · EP20 · EP22 · EP24 · EP26 · EP28 · EP30 · EP32
		EPR4 · EPR5 · EPR6 · EPR7 · EPR8
6.3 1/4"		EPR10 · EPR11 · EPR12 · EPR14 · EPR16
10 3/8"		EPR18 · EPR20 · EPR22 · EPR24 · EPR26 · EPR28 · EPR30 · EPR32
12.5 1/2"		



V7002/4

EAN 4047728079815

3/8" spark plug socket set

- Ball joints allow easy installation and removal in hard-to-reach places, e.g. on motorcycles or BMW N43 and N53 engines
- Magnetic
- Slim design
- Sizes: 14, 16, 18, 20.8 mm

10 3/8



VIGOR No.	Size	EAN 4047728+
V7002-14	14	079822
V7002-16	16	079839
V7002-18	18	079846
V7002-20.8	20.8	079853

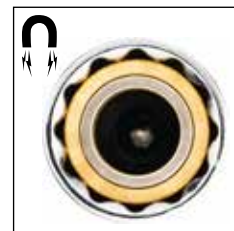

4

V5505N

EAN 4047728080484

Impact universal joint set

- Working in areas with restricted access, and for getting around obstructive edges

6.3 1/4 10 3/8 12.5 1/2
6.3 1/4 10 3/8 12.5 1/2

New



VIGOR No.	■	EAN 4047728+
V5505N-1/4	6.3 1/4	083324
V5505N-3/8	10 3/8	083317
V5505N-1/2	12.5 1/2	083300

3

V6504-250

EAN 4047728077750

Universal pliers with pushbutton · 250 mm

- Adjustment of the jaw opening at the touch of a button
- Locking of the hinge pin prevents unintentional adjustment
- Jaw opening: up to 65 mm
- Capacity for nuts, size 46 mm
- Capacity for pipes Ø 50 mm / Ø 2"
- Adjustment positions: 23
- Weight: 384 g



V6504-125

EAN 4047728082617

Universal pliers with pushbutton · 125 mm

- Adjustment of the jaw opening at the touch of a button
- Locking of the hinge pin prevents unintentional adjustment
- Jaw opening: up to 44 mm
- Capacity for nuts, size 27 mm
- Capacity for pipes Ø 29 mm / Ø 1"
- Adjustment positions: 15
- Weight: 89 g



New



PIPE WRENCHES

- Robust cast iron pliers body enables high power transmission
- Quick canting and release on the workpiece due to internal spring
- Coarse jaw serration for optimum grip



- Jaw opening: up to 60 mm
- Capacity for pipes: Ø 2"

HEAVY DUTY

Continuously adjustable



- Jaw opening: up to 88 mm
- Capacity for pipes: Ø 3"



VIGOR No.	Length mm	Weight kg	EAN 4047728+
V5639	350	1.3	075589
V5639-24	620	3.2	081719

V4640

EAN 4047728**081726**

Hose clamp pliers

- For operating hose and spring band hose clamps
- Rotatable jaws for confined spaces
- Locking element for temporary holding of the clamp



V4637N

EAN 4047728**075565**

Hose and spring band clamp pliers

- For operating hose and spring band hose clamps
- Thanks to a flexible bowden cable perfect for hard-to-reach self-gripping hose and spring band hose clamps
- Bowden cable locking element facilitates temporary holding of the clamp
- Total length of bowden cable: 590 mm
- Clamping range: 18 – 53 mm



V4641

EAN 4047728**075558**

Clamp pliers

- Operation of stepless and earless clamps on axle boots
- Also suitable for thermoplastic axle boots



V4737

EAN 4047728**075572**

Fuel line pliers

- Thanks to a flexible bowden cable perfect for hard-to-reach fuel couplings
- Total length of bowden cable: 590 mm
- Opening width: 30 mm



V5671N

EAN 4047728076715

MINI GIANT

1/2" impact wrench · mini

12⁵ 1/2



Size comparison between V5671N & V4800N

Ø mm	Nm	max. Nm	max. Nm	rpm	kg	l/min.	bar	m/s ²
12,91 (4) 7,2	600	850	1200	10000	1.28	141.5	6.3	6.81

1/2"
1200 Nm

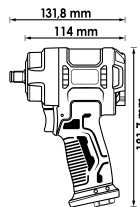

V4800N

EAN 4047728075633

ECO GIANT

1/2" impact wrench

12⁵ 1/2



Ø mm	Nm	max. Nm	max. Nm	rpm	kg	l/min.	bar	m/s ²
12,91 (4) 7,2	850	1100	1720	7000	2.30	198.1	6.3	6.47

1/2"
1720 Nm

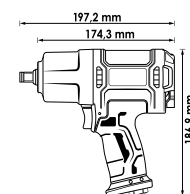

V6899N

EAN 4047728076944

GIGA GIANT

3/4" impact wrench

20 3/4



The most powerful in its class!

Ø mm	Nm	max. Nm	max. Nm	rpm	kg	l/min.	bar	m/s ²
16,41 (4) 7,2	1400	2000	2300	5500	3.60	254.8	6.3	5.75

3/4"
2300 Nm

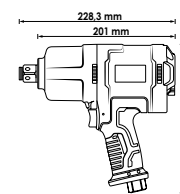

V6907

EAN 4047728075497

Mini grease gun

- Grease tube can be changed quickly due to the screw thread
- Feed rate: 0.45 ml / stroke
- Lubricating nipple in 30° and 90° designs
- M15 x 1.5 inside thread
- Grease tube not included in delivery



V6907-1

EAN 4047728075503

High-performance grease

- Replacement tube for V6907
- Provides corrosion protection due to good adhesion on metallic surfaces
- 100 ml filling capacity
- M15 x 1.5 outside thread



V7524

EAN 4047728**081320**

Flue gas leakage tester

For leakage detection in closed systems

- Leaks are quickly visualised through the application of flue gas
- Operation via the 12 V on-board power supply
- Pressurisation by means of "air" mode and integrated manometer possible without further aids
- Smoke generation with suitable aid (vegetable glycerine or baby care oil)
- Universal application option thanks to various adapters
- Built-in air compressor
- Automatic safety shutdown in case of imminent overheating
- Infinitely adjustable air flow

Diverse application possibilities, for example:

- Intake and boost pressure system
- Crankcase
- Exhaust gas and exhaust gas recirculation system
- Fuel system
- Adblue and additive system
- Tyres
- Air conditioning system
- EVAP fuel system (US vehicles)
- Car body and glazing (wind noise, moisture penetration, etc.)



VIGOR No.	Designation	EAN 4047728+
V7524-1	Power cable	081474
V7524-2	Smoke hose	081481
V7524-3	Conical adapter	081504
V7524-4	Valve extractor	081528
V7524-5	Air bellows adapter	081535
V7524-6	Hard rubber plug	081542
V7524-7	Plug for small lines	081559
V7524-8	Cover caps, red	081566
V7524-9	EVAP connection adapter	081573



V7524-10

EAN 4047728**084321**

Diagnostic liquid

- Ready-to-use diagnostic liquid for the generation of dense, white and odourless vapour in the Vigor V7524 flue gas leakage tester
- The liquid is non-toxic and biodegradable
- The quantity of 250 ml is sufficient for numerous applications



The perfect solution for every diagnosis – 250 ml diagnostic liquid!

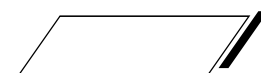

V4385N

EAN 4047728072601

Oil filling device with adapter set

- Filling gearboxes and differentials with oil
- Incl. oil pan and 16 adapters for vehicles with limited installation space



18

V7385

EAN 4047728077194



MERCEDES-BENZ 9G-Tronic gearbox tool set

- Includes all necessary tools for changing the oil in the 9-speed Tronic automatic gearbox
- For draining and filling the gearbox oil
- For gearboxes with designation 725 (725589029000, 725589009000)
- Drain wrench for adjusting the standpipe

Contents:

- 1 x oil filter adapter
- 1 x multifunction oil drain wrench
- 1 x oil drain plug wrench



4

V4941N

EAN 4047728077293

Injector sealing seat cleaning set

- Eliminating soot residues, particles on HDi, diesel direct injection and common rail engines with Bosch and Delphi injectors
- Including sealing plug for protection against combustion chamber contamination
- Centring crowns for accurate guiding



27

Now with even greater model coverage!

V6740

EAN 4047728077774

Ignition coil remover VAG

- Safe and damage-free removal of ignition coils with final output stage according to manufacturer's specifications, e.g. on 1.0 I / 1.0 I TSI / TFSI / TGI / GTI / CNG - 1.2 I TSI - 1.4 I-25/30/35/40/45 TSI / TFSI / TGI / CNG / GTE / Mild Hybrid / e-Hybrid - 1.6I/1.6I SRE / MPI- 2.0 I GTI
- Engines installed in the following models, among others:
 - AUDI A1, A3, A4, A5, Q2, Q3
 - SEAT Alhambra, Arona, Ateca, Cupra Formentor, Ibiza, Leon, Mii, Tarraco, Toledo
 - ŠKODA Citigo, Fabia, Kamiq, Karoq, Kodiaq, Octavia, Rapid, Scala, Superb, Yeti
 - VW Arteon, Beetle, Caddy, Golf 6-8, Jetta 4-7, CC, Passat B8, Polo 5-6, Scirocco, Sharan, T7, Taigo, Tiguan, Touran, T-Cross, T-Roc, Up
- Removal of both ignition coil versions possible:
 - 04C.905.110.J to 2017
 - 04E.905.110.K to 2017



V1963/28

EAN 4047728081467

Cooling system diagnosis set

New adapter series with approx. 20 % space saving per adapter!

- VIGOR cooling system lids build up approx. 20 % less height than comparable products on the market
- Comfortable and efficient work, by reaching almost all expansion tanks
- Greatest market coverage
- Including adapter no. 23 for common vehicle models such as AUDI A3 · A4 · VW Golf · Passat · Polo
- Passenger car diagnostics
- Complete set for service work on the cooling system and heating circuit
- Comprehensive range of adapters for vehicles with water-cooled engines
- 3 features: pressure test (check for leaks in radiator system) · filling · cleaning
- Control of pressure loss via manometer
- Filling creates a vacuum in the radiator system (Advantage: coolant is sucked in without air bubbles)
- Enables filling of even large engines without thermal influences
- Universal usage due to conical rubber radiator adapter
- Measuring range: 0–2.5 bar



New adapter series with approx. 20 % space saving per adapter!

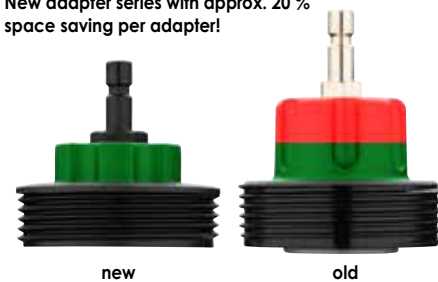

» **Largest model coverage on the market!**
Compatible with hybrid vehicles!

28



V7471/17

EAN 4047728077187

Brake bleeding complete set

For bleeding brake line systems and changing brake fluids

- Comfortable application thanks to ergonomic special ratchet
- Also for bleeding coupling systems
- Easy opening and closing of the brake nipple thanks to special hinge ratchet
- Guarantees fast access to the brake nipple even with the wheel mounted
- Good power transmission due to application-optimised handle
- Angle coupling piece in 90° design with back pressure valve and anti-rotation protection
- Back pressure valve protects system against ingress of air
- Socket inserts: size 7 – 12 mm, in short and long designs, included in delivery



Take a look!

17

V7401

EAN 4047728074018

Brake disc thickness gauge · digital

Measuring the minimum thickness of brake discs

- Performing the measurement without wheel removal
- Digital display, LCD display
- Stainless steel design
- Note: note the minimum wear limits of the brake discs from the vehicle manufacturer manual
- Including 3 volt battery CR2032
- Measuring range from 0 – 80 mm
- Automatic switch-off function



V6917

EAN 4047728069175

Brake line ratcheting tube cutter Ø 4.75 mm

- Space saving, with ratchet mechanism
- Ratcheting mechanism in the head of the tool minimises space required – can be used directly on the vehicle
- No readjustment of the cutting wheel due to self-adjustment
- Faster cutting result than with conventional line cutters
- Adjustment of the self-adjusting cutting force possible
- Spare blades V6917-REP



V7120

EAN 4047728077200

Brake line holding tool

- Non-damaging grip on Ø 4.75 mm brake lines thanks to optimised clamping
- The brake line can be re-bent in the installed state to replicate the exact shape of the original
- Suitable for steel, copper-nickel and plastic-coated brake lines



4

V4416

EAN 4047728044165

Tube flaring tool for Ø 4.75 mm brake lines

- Exclusively for DIN flaring
- Exact positioning of the brake line in the device using a spacing adapter
- Application on brake and hydraulic lines directly on the vehicle
- For thin-walled pipes made of steel, aluminium and copper (metric / inch)
- No damage to coated lines
- For DIN "F" flares 180°



V1711N

EAN 4047728060738

Brake piston readjusting tool set · pneumatic

- Pushing and turning of brake pistons on nearly all passenger cars
- Efficient work on brake systems
- For clockwise and anti-clockwise brake pistons
- In addition to pneumatic support, controlled rewinding by hand is also possible



23

V7158

EAN 4047728071581

Brake calliper screw connection set

- Brake calliper screw connection on e.g. **VW · AUDI · PORSCHE · MERCEDES-BENZ · BMW · FORD · MAZDA** and **Volvo**
- Including all common profile sizes for removal / installation of the brake calliper
- Special profiles for loosening the screw connections of separated brake callipers
- Ideal for floating and fixed brake callipers



12

V7259

EAN 4047728072595

Brake line bending tool

Bending device for easy duplication of brake pipes that keep their shape

- Suitable for steel, copper-nickel and plastic-coated brake lines
- Five different bending radii: 25 · 35 · 50 · 65 · 80 mm



V6312/10

EAN 4047728**077804**

1/2" impact socket set

- Damage-free operation of wheel bolts by rotating plastic sleeve
- Comprehensive set with all required sockets
- For impact operation
- Size 15 · 17 · 18.5 · 19 · 19.5 · 21 · 22 · 22.2 mm

12⁵ 1/2"



FORD



KIA



MERCEDES-BENZ



10



15 mm



17 mm



19 mm



21 mm



22 mm



17 mm

MERCEDES-BENZ



18.5 mm

FORD



19.5 mm



21 mm

KIA / HYUNDAI



7/8"

TESLA

V6309

EAN 4047728**075534**

Impact socket set FORD

- Operation of damaged 19 mm FORD wheel nuts
- Length: 80 mm
- For e.g.:
 - FORD B-Max · C-Max · Fiesta · Focus · Mondeo · Transit

12⁵ 1/2"



18.5MM

VIGOR



19.5MM

VIGOR

For wheel nuts 21 mm



For wheel nuts 19 mm

V6313

EAN 4047728**083331**

Impact socket set

- Operation of damaged 21 mm wheel nuts
- 20.5 mm impact socket for wheel nuts with missing chrome cap
- 21.5 mm impact socket for wheel nuts with deformed chrome cap

12⁵ 1/2"

New



20.5MM

VIGOR



21.5MM

VIGOR

2

2

V5933/3

EAN 4047728**079624**

1/2" impact socket set · extra long

- Damage-free operation of wheel bolts by rotating plastic sleeve
- Extra long design
- For impact operation



12⁵ 1/2"



VIGOR No.		Length mm	Size mm	EAN 4047728+
V5930	12 ⁵ 1/2"	150	17	059305
V5931	12 ⁵ 1/2"	150	19	060318
V5932	12 ⁵ 1/2"	150	21	079617

3

V7001

EAN 4047728**075060**

Universal rim lock removal set

- Malleable rim keys for loosening almost all rim locks
- Also for rim locks with clover leaf profile, among others
- Malleable rim keys adapt to the profile by hammer strike
- Rim keys can be used on both sides
- After forming a rim key, all four rim locks of a vehicle can be released
- Multiple deformation of a key side not possible

Contents:

- 8 rim keys
- 2 adapters
- Socket 1/2" – size 24 mm
- Impact body
- Centring pin
- Hand guard trim



Take a look!



13

1/2" TORQUE WRENCHES

- Torque release: palpable and audible
- Release accuracy tolerance ± 4% of the scale value (in direction of actuation)
- With serial number and certificate
- DIN EN ISO 6789-2:2017, DIN 3120, ISO 1174-1A

±4%

12⁵ 1/2"



VIGOR No.	Nm		Length mm	Tolerance %	EAN 4047728+
V3898	20 – 120	12 ⁵ 1/2"	445	4	038980
V3441	40 – 200	12 ⁵ 1/2"	540	4	034418
V3899	60 – 320	12 ⁵ 1/2"	610	4	038997

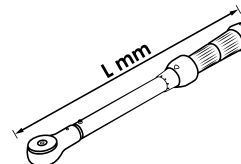

NITRILE GLOVES

Protect hands from oil, grease, chemicals and dirt

- Surface structure provides good adhesion, even in oily working conditions
- Safety colour orange for better visibility in dark work spaces
- Comfortable, tear-resistant glove with good dexterity
- Touchscreen compatible
- Material: Nitrile
- Latex and powder free

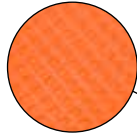

VIGOR No.		Size	EAN 4047728+
V6436-M	100 pcs./carton	M	080118
V6436-L	100 pcs./carton	L	077712
V6436-XL	90 pcs./carton	XL	077729
V6436-XXL	90 pcs./carton	XXL	077736

V3551N

EAN 4047728**075084**

Repair set for plastic parts

- Repair and reinforcement of plastic parts
- Extensive use and practical for household, workshop or handicraft
- Plastic parts such as containers, components of any kind or cladding can be repaired immediately
- 3-in-1 function with replaceable fixtures
- Power: 50 watts
- Maximum useful life: 35 minutes
- Charging time: 3.5 hours

Contents:

- 1 basic unit
- 1 equipment stand
- 1 charging cable
- 50 repair staples type W / Ø 0.6 mm
- 50 repair staples type W / Ø 0.8 mm
- Welding rods: 5 x PE, 5 x PS, 5 x ABS, 10 x PP
- 2 reinforced grids
- 3 adapters



133

V4891-1.0

EAN 4047728**080217**

Induction heater · 1.0 kW

- Compact induction heater for flameless heating of components and work pieces
- Risk minimisation compared to oxy-acetylene burners
- LED on the coil head indicates operation
- Compact unit in relation to the output power of 1.0 kW
- Precise heating in just a few seconds with cutting-edge microprocessor technology
- Power supply: 230 V

Contents:

- V4891-1 (rigid coil)
- V4891-2 (flexible coil)
- V4891-3 (rigid coil)
- V4891-4 (flat coil)



V4891-1

V4891-2

V4891-3

V4891-4

5

1.0
kw

V4891

EAN 4047728048910

1.5
kw

Induction heater · 1.5 kW

- Modern and efficient heating - prevents damage to surrounding components
- Targeted heating within seconds
- Prevention of overheating with a simultaneously high degree of efficiency due to two fans
- Connecting cable: 3 m
- Reel hose length: 700 m
- Controlled fan cooling
- Tube coils: heating pipes, bolts, profiles of various diameters
- Flexible coil: for loosening parts that are difficult to access due to the use of a special winding wire
- Flat coil: for heating the car body and sheet metal, makes it easier to remove stickers, sealants etc.
- Weight: 4.5 kg

Contents:

- V4891-1 (rigid coil)
- V4891-2 (flexible coil)
- V4891-3 (rigid coil)
- V4891-4 (flat coil)



V4891-1

V4891-2

V4891-3

V4891-4

5

V4891-3.5

EAN 4047728072779

3.5
kw

Induction heater · 3.5 kW

- Modern and efficient heating - prevents damage to surrounding components
- Targeted heating within seconds
- Cooling fluid and focus coil included in delivery
- Water cooling up to the coil head
- Avoidance of overheating thanks to integrated ventilator
- Extensive accessories for various application fields
- Highest possible capacity in compact design
- Output power can be precisely adjusted for the application field - from 10 - 100%
- Operating information via LED display on the handle



2

V4891-10.0

EAN 4047728077958

10.0
kw

Induction heater · 10.0 kW

- Ultra-strong 10.0 kW variant for heating solid components
- Mobile unit with chassis and integrated water cooling system
- Quiet operation
- Efficient method of heating, without damaging surrounding components
- Risk minimisation compared to oxy-acetylene burners
- 10 litre-water cooled
- Compact unit in relation to the output power of 10.0 kW
- Output power can be precisely adjusted for the application field
- Stepless power control from 10 to 100 percent
- Delivery includes cooling fluid
- LED on the coil head indicates operation
- Precise heating in just a few seconds with cutting-edge microprocessor technology
- Power supply 400 V – 32A



Heavy current connection required!



2



New

Now also with Ø 3.9 mm probe!



VIDEO BORESCOPE

Analysis and documentation of damage patterns in difficult to access spaces!

- Probe: Ø 3.9 mm or Ø 4.9 mm
- Probe length: 1000 mm
- Camera resolution: 1280 x 720 (corresponds to HD quality)
- Camera viewing angle: 80°
- 6 dimmable LEDs
- Depth of field: 20 – 80 mm
- 5" display, swivelling
- Display resolution: 1280 x 720 pixels
- 6 Ah, 3.7 V Li-ion rechargeable battery
- 2A/5V power supply unit, USB charging cable and 32 GB TF memory card included in delivery



Screen can be moved freely in all directions



Swivels 180° on both sides

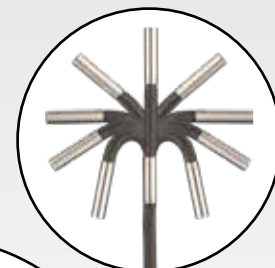

Comparison

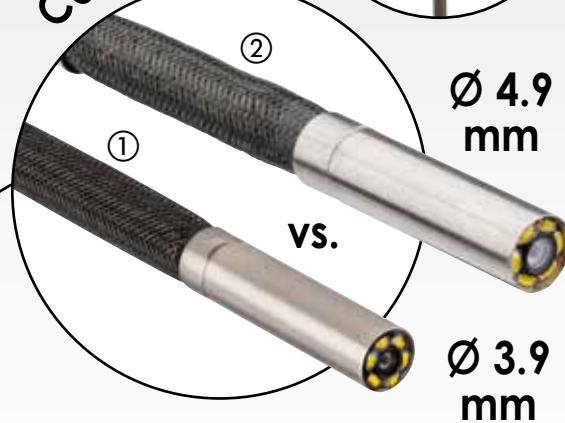

vs.

Ø 4.9 mm

Ø 3.9 mm



	VIGOR No.	Designation	Ø mm	EAN 4047728+
①	V7501-39	Video borescope with probe	3.9	082037
②	V7501/2	Video borescope with probe	4.9	080255



Your VIGOR specialist dealer:



VIGOR GmbH · Am Langen Siepen 13–15 · 42857 Remscheid · GERMANY
www.vigor-equipment.com · info@vigor-equipment.com

EINFACH VIGOR.

Valid from 01/03/2024 to 31/08/2024 – errors excepted

HOT24-1/EN/XXX/01.03.2024 / pdf.rsn

CHASSIS SPECIALTY TOOLS



V5916

EAN 4047728059817

Ball joint ejector

- For the hydraulic removal of the ball joint pivots on steering tie rods as well as stabilisers with a maximum compressive force of 4.5 tonnes



4.5t



2

V5916-1

EAN 4047728072953

Pressing tool with bolt

- Extension for ball joint ejector V5916
- Pressing out ball joints and steering tie rod ends with bolts instead of nut threaded connections on the cone axis
- Pressing tool can be adapted and adjusted individually to the installation situation



V5916-2

EAN 4047728073554

Pressure foot extension

- Extension for ball joint ejector V5916
- For ball joint pins with a length over 72 mm
- Used in e.g. SUVs and commercial vehicles from CHEVROLET or GMC
- Set consisting of pressing tool and pressing piece
- Can be used in constricted spaces



2

V5916-XL

EAN 4047728066471

Ball joint ejector

- For the hydraulic removal of the ball joint pivots on steering tie rods as well as stabilisers, or steering and brake lever for trucks and buses, with a maximum compressive force of 8.8 tonnes



8.8t

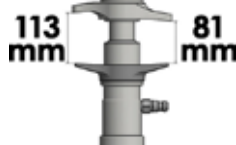

3

V8327

EAN 4047728083270

Axle shaft removal set · gearbox side

- Powerful, efficient removal tool for outer homocinetic joint
- Prevents pulling, hammering and damage to the spherical joint bearing
- Contains 5 kg sliding hammer and strong axle support with chain tensioner
- Enables removal directly on the vehicle
- Secures the joint in the puller to prevent accidents and dirt
- Sliding hammer V2922 M18 x 2.5



V8327-1

EAN 4047728083287

Axle shaft puller outer joint

- Extension for removal of the homocinetic joint
- Additional sliding hammer V2922 is required
- Socket M18 x 2.5

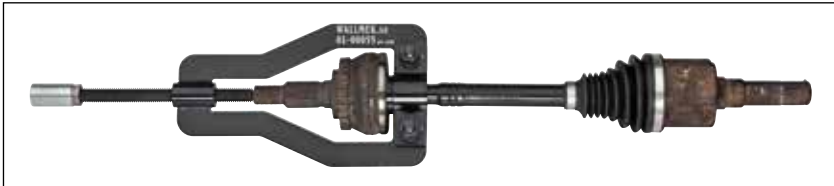

V8327-2

EAN 4047728083294

Support

- Support device for locking the axle shaft in the gearbox
- Prevents the entire axle shaft from being removed while the outer joint is being dismantled

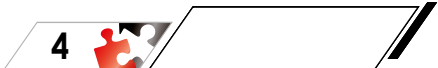

V7862

EAN 4047728**078627**

Axle shaft removal set

- Removal of the inner axle shaft from the gearbox unit
- Full gripping of the axle shaft prevents damage caused by hammering or pulling
- Variable settings of the axle shaft holder allow optimum access to the shaft
- Depending on the installation situation, the holder can be disassembled into two parts and clamped around the axle shaft
- Universally adjustable holder allows use from small cars to commercial vehicles
- Use with 5 kg sliding hammer V2922

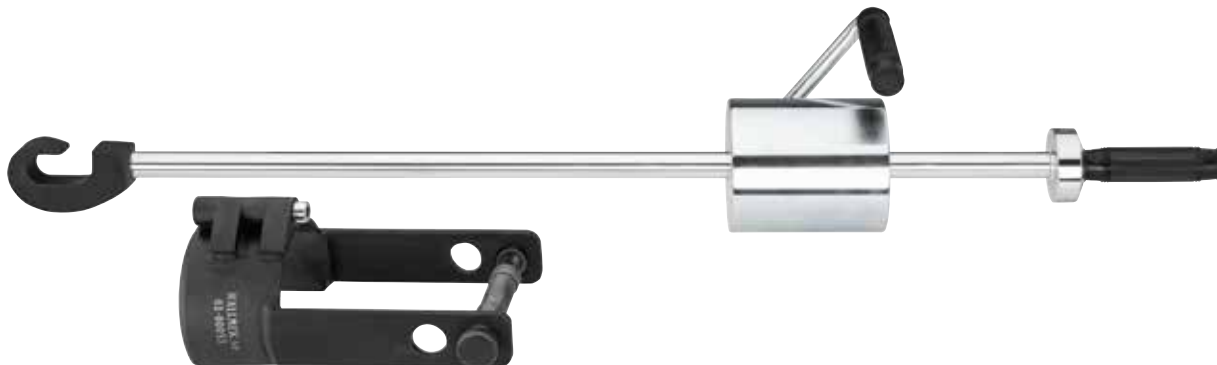

3



V7980

EAN 4047728**079808**

Axle shaft removal expansion set

- Adjustable pull cage for removing the axle shaft on the gearbox side
- With the help of the variably adjustable pull cage, the shaft is brought into a horizontal position and removed using the sliding hammer V2922
- Levering or non-centred removal of the shaft can damage the gearbox
- Only to be used together with sliding hammer V2922



2





V7201

Compact wheel bearing removal / installation set

- For removing and installing compact wheel bearings with or without circlip
- Adjustability enables use on all types of currently available and future compact wheel bearings



Installation



Removal



V4906N

Standard wheel bearing removal / installation set

- New effective method for removing wheel hubs; the use of wheel bearing set V4598 is recommended here. The set also functions with steering knuckles with uneven and limited surfaces
- Allows the wheel bearings to be changed directly on the vehicle with minimum effort
- Mounting washers with a diameter of 62 – 83 mm and support discs of 34 – 60 mm are included; the bearing shell is suitable for wheel bearings of up to 92 mm in diameter



V5549-1N

Expansion set for compact wheel bearings

- Set contains 4 expansions:
 1. Disassembly feet for screwed compact wheel bearings (3 bolts)
 2. Disassembly feet for screwed compact wheel bearings (4 bolts)
 3. Disassembly unit of the wheel hub without prior removal of the drive shaft
 4. Disassembly unit of the screwed wheel bearing without prior removal of the drive shaft
- Especially for expanding and completing compact wheel bearing sets
- When combined with the base unit V4680, all commercially available compact wheel bearings can be removed / installed



Screwed wheel bearing units – 3 bolts



Screwed wheel bearing units – 4 bolts



Removal of the wheel hub without removing the drive shaft



Removal of the wheel bearing without removing the drive shaft



V7722

Press frame expansion set

- Set contains:
 - 14 t compressive hydraulic cylinder including thrust rod M 24
 - Support set 275 mm
 - Open plate including screw M 16 x 40 mm



V7723

Drawbar expansion set

- Universal expansion for 18 t and 22 t hydraulic cylinder
- Spindle set makes it possible to remove and insert even more bushings and bearings with various inside diameters
- Set contains:
 - Adapter: M 22 – M 10 · M 22 – M 12 · M 22 – M 14 · M 18 – M 22
 - 4 drawbars including flange nuts: M 10 x 1.5 · M 12 x 1.75 · M 14 x 2.0 · M 20 x 2.5
 - Striker nut M 18





V5741N

Rear axle longitudinal control arm · silent block FORD, MAZDA, Volvo

- For changing the bushing of the front longitudinal strut in the rear area and for changing the rear axle bushings
- Do not load the bushing and press frame with more than 22 tonnes



V7030-2

EAN 4047728077323

Mobile passenger car work bench with specialty tool assortment

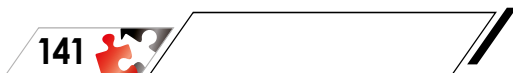

Pressure sleeve set

- Including 24 pressure pieces of different sizes
- Sleeves with small diameters are reversible
- Adapter and pressure shaft enable application of the press frame V2885–useful when removing or installing bushings and supporting joints without holes

» **UPDATE: now even more fields of application!**



V5066



V2846



Incl. container for storing the pump.

Pneumatic foot pump

- Design with manometer
- For all hydraulic cylinders
- Working pressure: 700 bar
- Hose length: 2.2 m
- Oil tank: 1.3 l

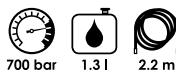

V7724

Ball joint ejector

- Set for universal removal of ball joints with 4.5 t compressive force
- Contains hydraulic unit V5916 and expansions V5916-1 and V5916-2
- V5916-1: Pressing out ball joints as well as steering tie rod ends, with bolts instead of nut threaded connections on the cone axis
- V5916-2: For ball joint pins with a length over 72 mm



V5916

Set of devices for the removal of drive shafts

- For passenger cars with T4 and 5-hole wheel hubs due to oval holes for wheel bolts
- Prevents heating of or damage to the drive shaft or damage to other parts



V4904

V8366

EAN 4047728083669

Specialty tool extension

- Specialty tool set as an ideal extension to the V7026 and V7030 chassis assortments
- Useful extensions for centring compact wheel bearings during installation
- Universal pressure sleeves with outer diameters from 28.6 to 44.7 mm
- Cylinder holder for convenient working with the hydraulic system

XL

2 K



New



40



V8313

EAN 4047728083133

Adapter plate "Rescue"

- Adapter plate for universal support on the steering knuckle housing during wheel bearing replacement
- For use together with wheel bearing set V5128

18t/22t



New



V4680

EAN 4047728046800

Compact wheel bearing removal and installation set

- For removing and installing compact wheel bearings with or without circlip
- Use with hydraulic cylinder, mechanical spindle or workshop press
- Max. load: 22 t
- Pump not included in delivery
- For e.g.:
 - **VOLKSWAGEN:** Polo, Lupo, Touareg, Fox, T5 front and rear, Crafter
 - **AUDI:** A2
 - **SEAT:** Ibiza, Córdoba
 - **ŠKODA:** Fabia, Rapid, Roomster
 - **FORD:** Focus, C-Max, Mondeo, S-Max, Kuga, etc.

Compact wheel bearing



Basic set

15



V5554

EAN 4047728055543

Compact wheel bearing expansion set 1

- Hydraulic foot pump with V4680 and hydraulic cylinder

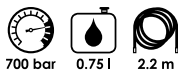

- Non-drip quick coupling
- For all hydraulic cylinders



Basic set

V2847



Hydraulic cylinder including accessories

28



V5554-2

EAN 4047728069021

Compact wheel bearing expansion set 2

- Pneumatic foot pump with V4680 and hydraulic cylinder

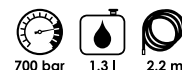

- Design with manometer
- Non-drip quick coupling
- For all hydraulic cylinders



V2846



Basic set



Hydraulic cylinder including accessories

28



V2800-OEL

EAN 4047728081276

Hydraulic oil "Power"

- Hydraulic oil, Power 32 HVLP, is a hydraulic oil with high viscosity index (VI), especially for hydraulic systems in mobile equipment and outdoor use
- Meets the following specifications and requirements: DIN 51524 Part 2 HLP, HVLP, -ISO 11158HV - AFNOR NFE 48-603
- Specially suitable for all hydraulic cylinders and pumps
- Pumps: V2846, V2847
- Hydraulic cylinders: V2873, V2869, V4551, V2854, V2874, V4229, V5916, V5916-XL



V4476N

EAN 4047728068000



Hydraulic spring vice

- Can be used for almost any strut and shock absorber in passenger cars as well as lightweight vans

① Pre-tensioning the spring



② Tensioning the spring



③ Support device



A safety tool with technical sophistication!

2.1t

16

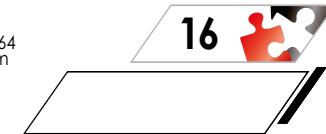

Including 10 spring plates



Take a look!



V4476N-1

EAN 4047728081597

Spring vice pre-tensioning unit

- Quick and efficient removal and installation of MacPherson spring strut in the installed state
- Depending on the spring strut, the lower spring plate or the first coil is applied and pressed with the aid of the pressing jaws
- To separate the shock absorber unit from the steering knuckle
- It is not necessary to loosen the cardan shaft, steering tie rod or axle control arm
- Hydraulic pump V2846 or V2847 is required



V4476N-2

EAN 4047728081603

Expansion set

- To upgrade the pre-tensioning unit V4476N-1 to the complete spring vice V4476N



② + ③

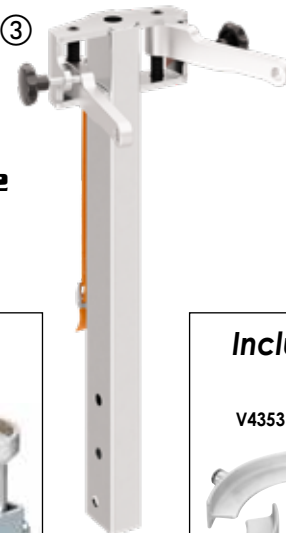

V4476N-1 + V4476N-2 = V4476N

Including 4 spring plates

V4353 V4352

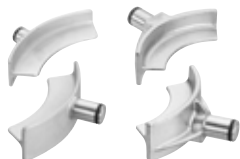

Including support device



Including 6 spring plates

V4353 V4352 V4354



5

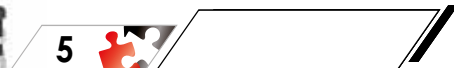

7

